

NO.	COMPONENTS	IMPEDANCE
1	SMA FEMALE	50 OHM
2	JBY240	50 OHM
3	HEAT SHRINKING TUBE	
4	N MALE	50 OHM

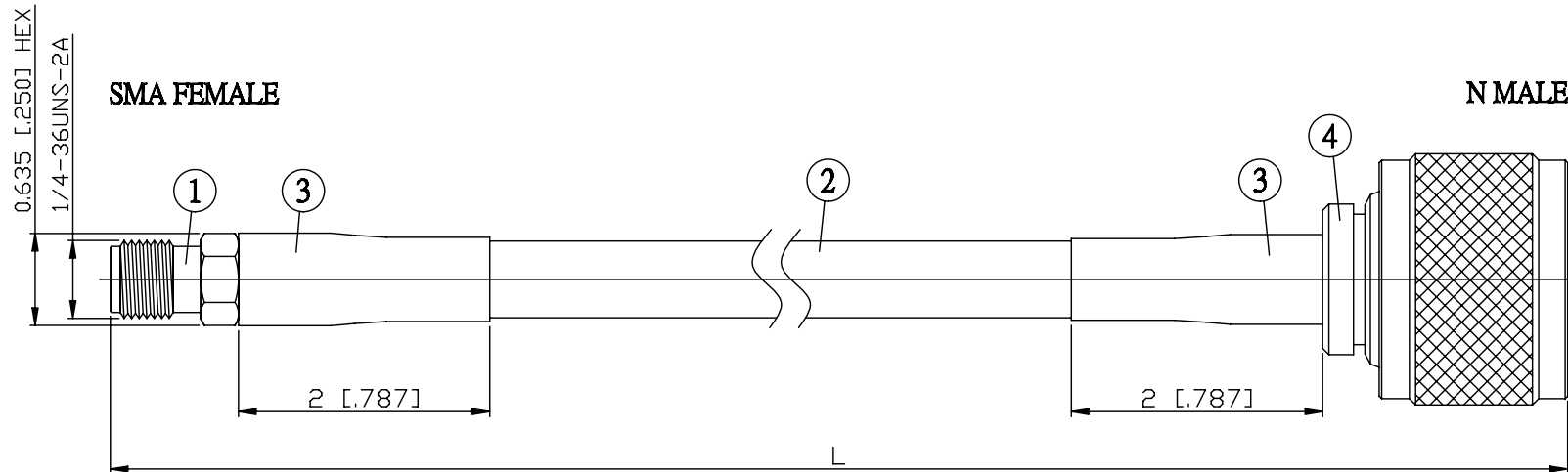

JYE BAO P/N	L CM (INCH)
A80N30-L240-15	15 (5.906)
A80N30-L240-30	30 (11.811)
A80N30-L240-50	50 (19.685)
A80N30-L240-100	100 (39.370)
A80N30-L240-150	150 (59.055)
A80N30-L240-200	200 (78.740)
A80N30-L240-XXX	CUSTOM LENGTH IN CM

LENGTH TOLERANCE IS $\pm 1.5\%$ OR $\pm 10\text{MM}$, WHICHEVER IS GREATER.	JYE BAO CO., LTD. TAIPEI TAIWAN
	DESCRIPTION CABLE ASSEMBLY SMA JACK TO N PLUG
	JYE BAO DRAWING NO. A80N30-L240-XXX