

NO.	COMPONENTS	IMPEDANCE
1	SMA FEMALE	50 OHM
2	.085" TIN PLATED SEMI-RIGID CABLE (TIN PLATED RG405)	50 OHM
3	BNC REVERSE POLARITY MALE	50 OHM

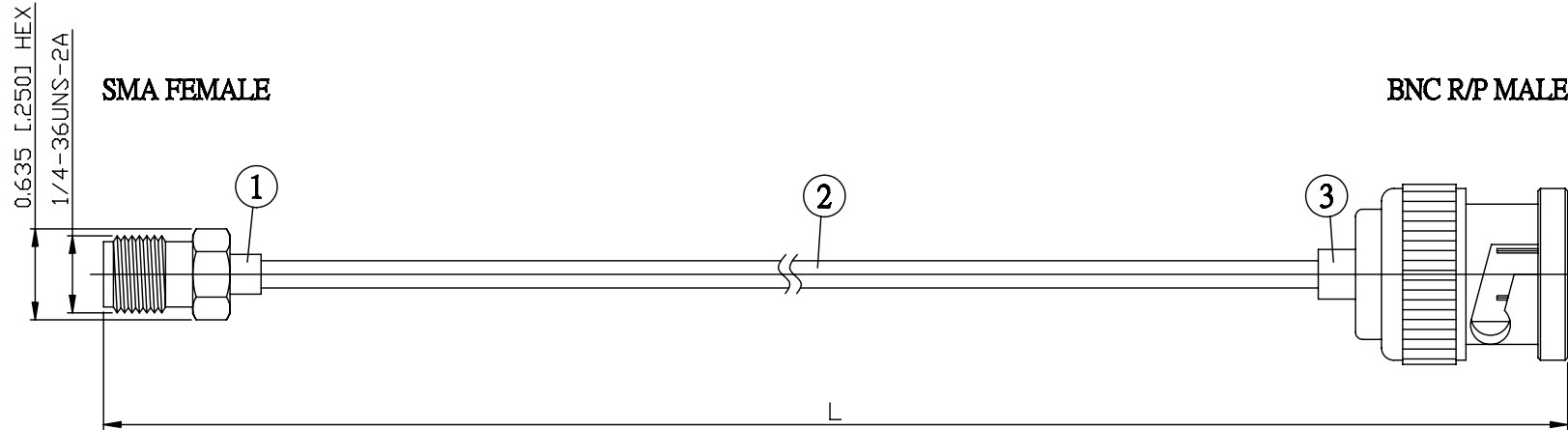

JYE BAO P/N	L CM (INCH)
A80B60-85T-15	15 (5.906)
A80B60-85T-30	30 (11.811)
A80B60-85T-50	50 (19.685)
A80B60-85T-100	100 (39.370)
A80B60-85T-150	150 (59.055)
A80B60-85T-200	200 (78.740)
A80B60-85T-XXX	CUSTOM LENGTH IN CM

LENGTH TOLERANCE IS $\pm 1.5\%$ OR $\pm 10\text{MM}$, WHICHEVER IS GREATER.	JYE BAO CO., LTD. TAIPEI TAIWAN
	DESCRIPTION CABLE ASSEMBLY SMA JACK TO BNC R/P PLUG
	JYE BAO DRAWING NO. A80B60-85T-XXX