

NO.	COMPONENTS	IMPEDANCE
1	SMA FEMALE	50 OHM
2	.085" HANDBENDABLE CABLE (= JYEBAO P/N .085SRF-W-P-50)	50 OHM
3	SMA REVERSE POLARITY FEMALE	50 OHM

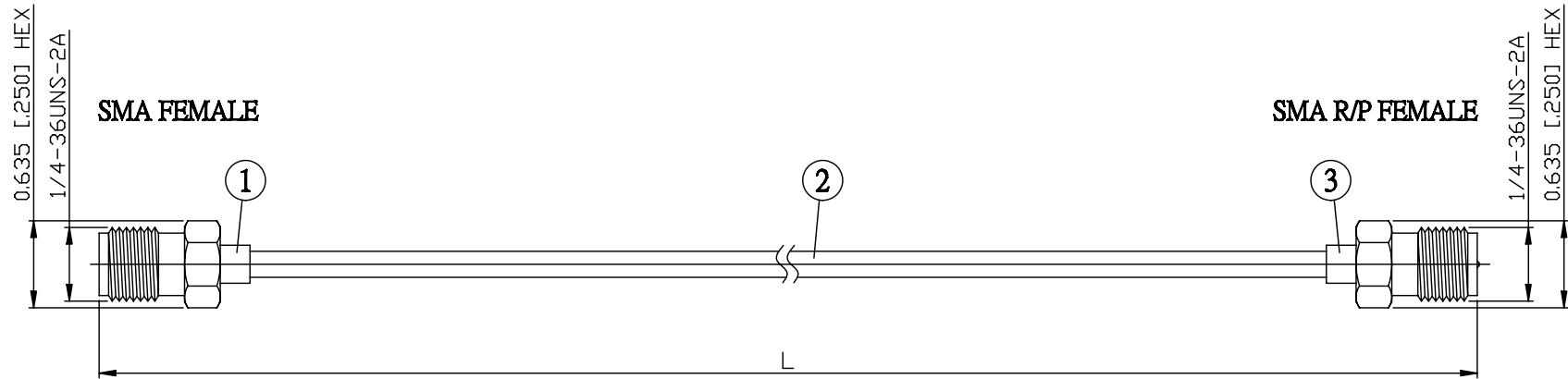

JYE BAO P/N	L CM (INCH)
A80A90-85S-15	15 (5.906)
A80A90-85S-30	30 (11.811)
A80A90-85S-50	50 (19.685)
A80A90-85S-100	100 (39.370)
A80A90-85S-150	150 (59.055)
A80A90-85S-200	200 (78.740)
A80A90-85S-XXX	CUSTOM LENGTH IN CM

LENGTH TOLERANCE IS $\pm 1.5\%$ OR $\pm 10\text{MM}$ , WHICHEVER IS GREATER.	<b>JYE BAO CO., LTD.</b> TAIPEI TAIWAN
	DESCRIPTION CABLE ASSEMBLY SMA JACK TO SMA R/P JACK
	JYE BAO DRAWING NO. A80A90-85S-XXX