

NO.	COMPONENTS	IMPEDANCE
1	SMA REVERSE POLARITY MALE RIGHT ANGLE	50 OHM
2	JBY240	50 OHM
3	HEAT SHRINKING TUBE	
4	SMA REVERSE POLARITY FEMALE FOR BULKHEAD	50 OHM

REVISION			
REV.	DESCRIPTION	DATE	APPROVED
-	INITIAL RELEASE	2012/08/15	
A	修正SMA螺紋規格	2013/10/01	

SMA R/P MALE
RIGHT ANGLE

SMA R/P FEMALE
FOR BULKHEAD

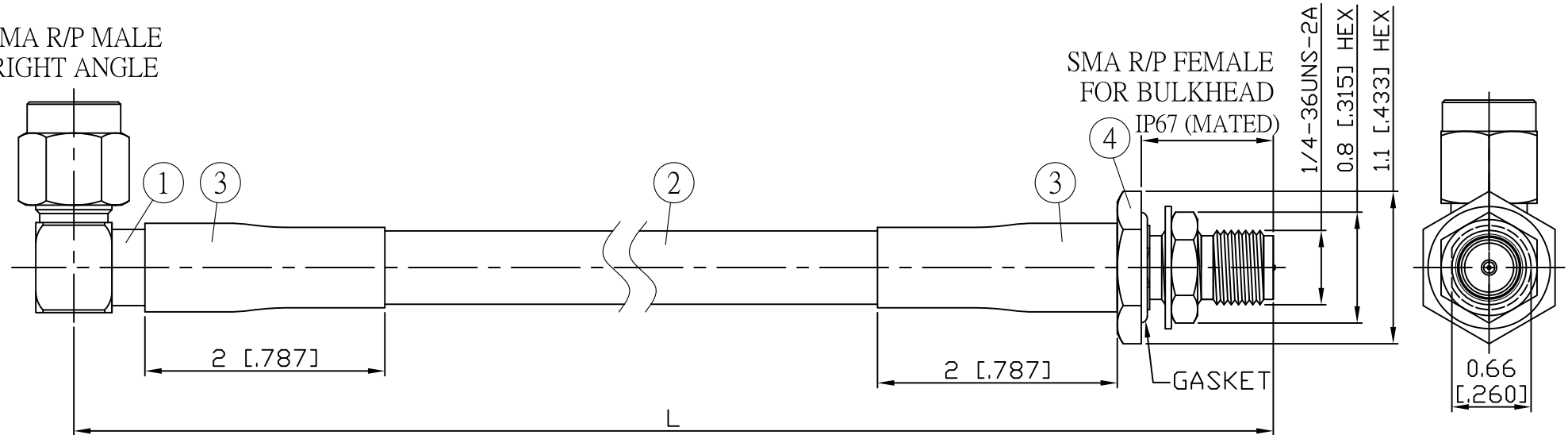

JYE BAO P/N	L CM (INCH)	L1 FT (MM)
A69A95-L240-15	15 (5.906)	0.459 (140.0)
A69A95-L240-30	30 (11.811)	0.951 (290.0)
A69A95-L240-50	50 (19.685)	1.608 (490.0)
A69A95-L240-100	100 (39.370)	3.248 (990.0)
A69A95-L240-150	150 (59.055)	4.888 (1490.0)
A69A95-L240-200	200 (78.740)	6.529 (1990.0)
A69A95-L240-XXX	CUSTOM LENGTH IN CM	- - -

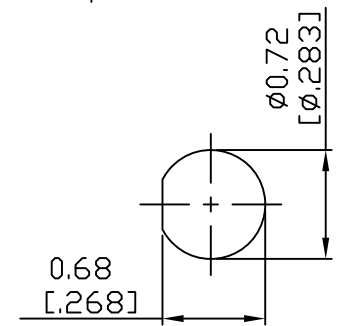

MOUNTING HOLE

					STANDARD	REV A	UNIT CM(INCH)	JYE BAO CO., LTD.	
					APPROVED			TAIPEI TAIWAN	
					CHECKED		DATE	DESCRIPTION CABLE ASSEMBLY SMA R/P PLUG R/A TO SMA R/P JACK FOR BULKHEAD	
					DRAWING	Albert	DATE	JYE BAO DRAWING NO. A69A95-L240-XXX	
4	SMA9105-L240	SMA R/P JACK	1	EA	LENGTH TOLERANCE IS ±1.5% OR ±10MM, WHICHEVER IS GREATER.				
3	G5(F)-8.0MM-BLACK	TUBE	0.04	M					
2	JBY240	CABLE	L1 (SEE TABLE)	FT					
1	SMA6100-9L240	SMA R/P PLUG R/A	1	EA					
NO.	PARTS NO.	DESCRIPTION	Q'TY	U/M					