

NO.	COMPONENTS	IMPEDANCE
1	SMA REVERSE POLARITY MALE RIGHT ANGLE	50 OHM
2	RG174	50 OHM
3	HEAT SHRINKING TUBE	
4	SMA FEMALE FOR BULKHEAD	50 OHM

REVISION			
REV.	DESCRIPTON	DATE	APPROVED
-	INITIAL RELEASE	2012/08/15	
A	修正SMA螺紋規格	2013/10/01	

SMA R/P MALE
RIGHT ANGLE

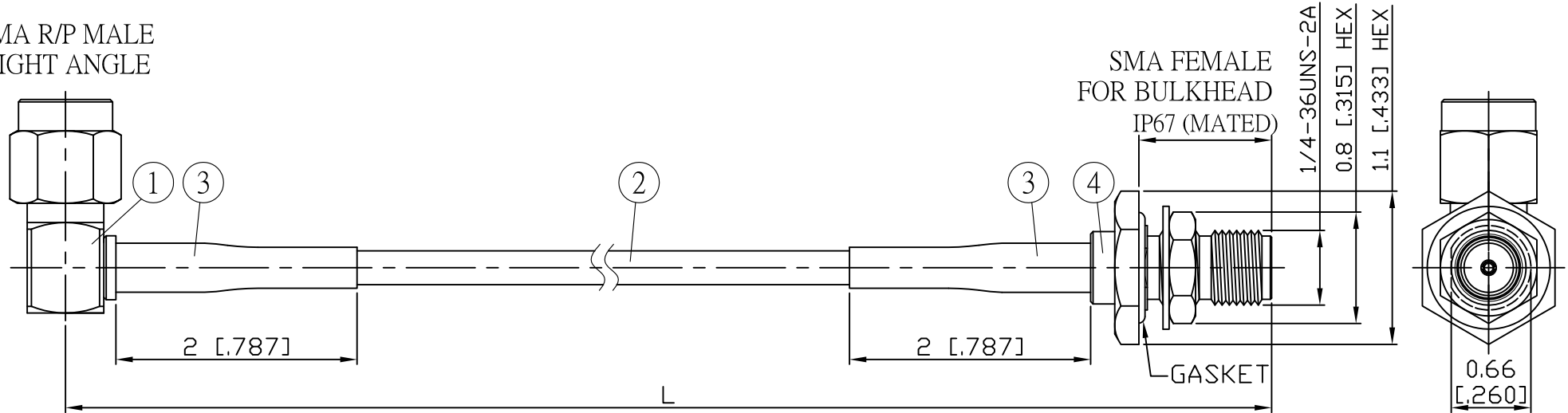

JYE BAO P/N	L CM (INCH)	L1 FT (MM)
A69A85-174-15	15 (5.906)	0.476 (145.0)
A69A85-174-30	30 (11.811)	0.968 (295.0)
A69A85-174-50	50 (19.685)	1.624 (495.0)
A69A85-174-100	100 (39.370)	3.264 (995.0)
A69A85-174-150	150 (59.055)	4.905 (1495.0)
A69A85-174-200	200 (78.740)	6.545 (1995.0)
A69A85-174-XXX	CUSTOM LENGTH IN CM	- - -

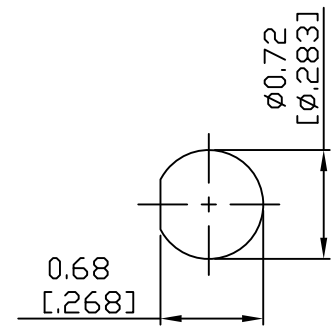

MOUNTING HOLE

				STANDARD	REV A	UNIT CM(INCH)	JYE BAO CO., LTD.	
				APPROVED			TAIPEI TAIWAN	
				CHECKED		DATE	DESCRIPTION CABLE ASSEMBLY SMA R/P PLUG R/A TO SMA JACK FOR BULKHEAD	
				DRAWING	Albert	DATE	JYE BAO DRAWING NO. A69A85-174-XXX	
4	SMA8105-0316	SMA JACK	1	EA	LENGTH TOLERANCE IS ±1.5% OR ±10MM, WHICHEVER IS GREATER.			
3	G5(F)-4.0MM-BLACK	TUBE	0.04	M				
2	RG174	CABLE	L1 (SEE TABLE)	FT				
1	SMA6100-9316	SMA R/P PLUG R/A	1	EA				
NO.	PARTS NO.	DESCRIPTION	Q'TY	U/M				