

NO.	COMPONENTS	IMPEDANCE
1	SMA REVERSE POLARITY MALE	50 OHM
2	RG213	50 OHM
3	HEAT SHRINKING TUBE	
4	N MALE RIGHT ANGLE	50 OHM

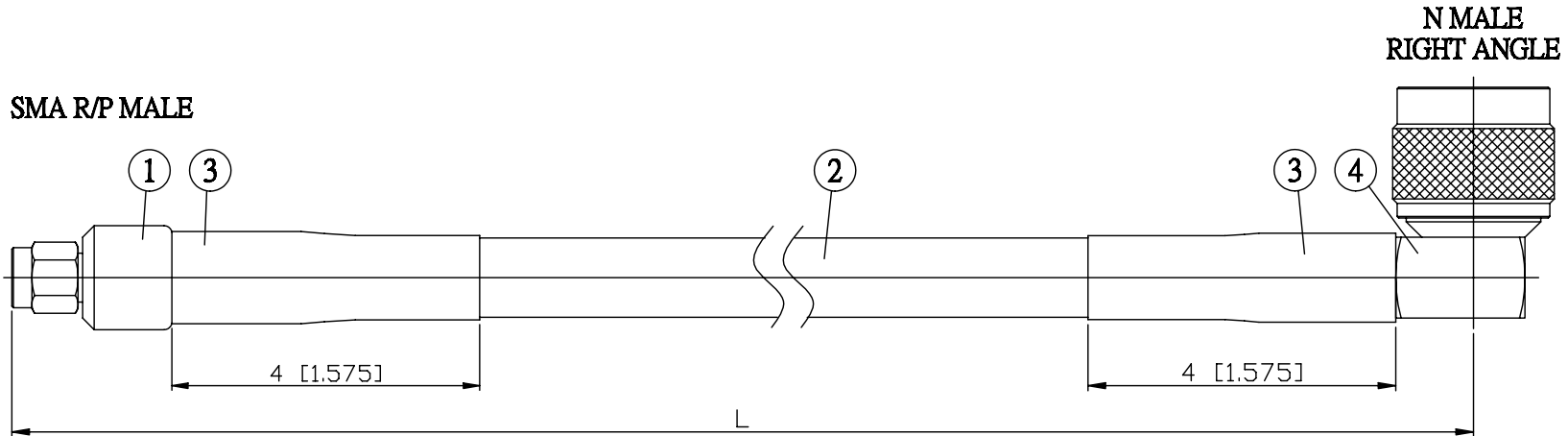

JYE BAO P/N	L CM (INCH)
A60N39-213-15	15 (5.906)
A60N39-213-30	30 (11.811)
A60N39-213-50	50 (19.685)
A60N39-213-100	100 (39.370)
A60N39-213-150	150 (59.055)
A60N39-213-200	200 (78.740)
A60N39-213-XXX	CUSTOM LENGTH IN CM

LENGTH TOLERANCE IS $\pm 1.5\%$ OR $\pm 10\text{MM}$ , WHICHEVER IS GREATER.	<b>JYE BAO CO., LTD.</b> TAIPEI TAIWAN
	DESCRIPTION CABLE ASSEMBLY SMA R/P PLUG TO N PLUG R/A
	JYE BAO DRAWING NO. A60N39-213-XXX