

NO.	COMPONENTS	IMPEDANCE
1	SMA REVERSE POLARITY MALE	50 OHM
2	RG316	50 OHM
3	HEAT SHRINKING TUBE	
4	SMA REVERSE POLARITY FEMALE FOR BULKHEAD	50 OHM

REVISION			
REV.	DESCRIPTION	DATE	APPROVED
-	INITIAL RELEASE	2012/08/15	
A	修正SMA螺紋規格	2013/10/01	

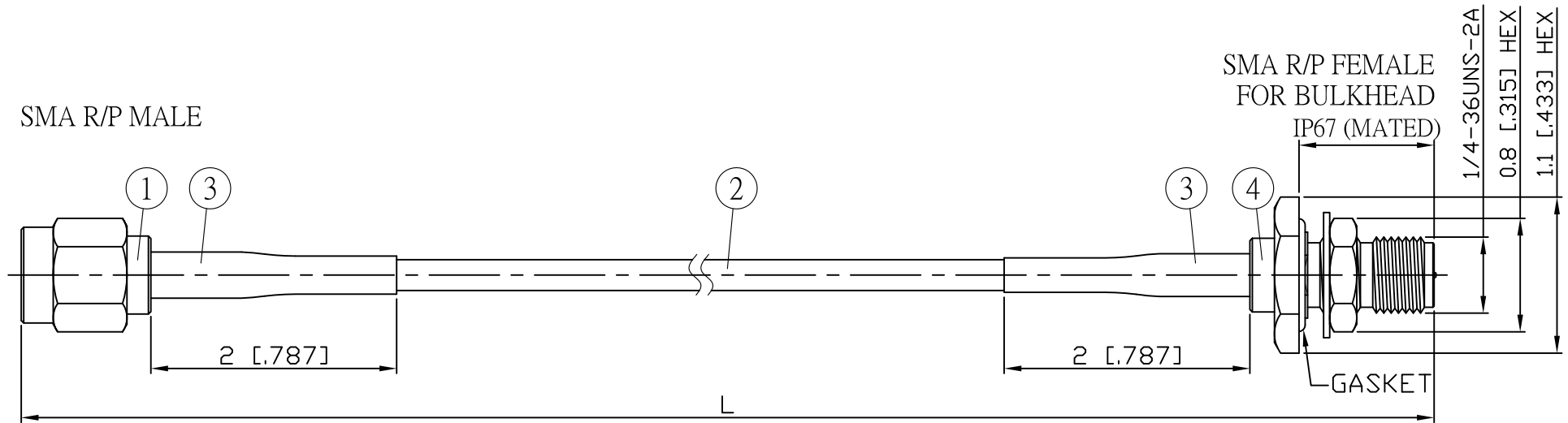

JYE BAO P/N	L CM (INCH)	L1 FT (MM)
A60A95-316-15	15 (5.906)	0.449 (137.0)
A60A95-316-30	30 (11.811)	0.942 (287.0)
A60A95-316-50	50 (19.685)	1.598 (487.0)
A60A95-316-100	100 (39.370)	3.238 (987.0)
A60A95-316-150	150 (59.055)	4.879 (1487.0)
A60A95-316-200	200 (78.740)	6.519 (1987.0)
A60A95-316-XXX	CUSTOM LENGTH IN CM	- - -

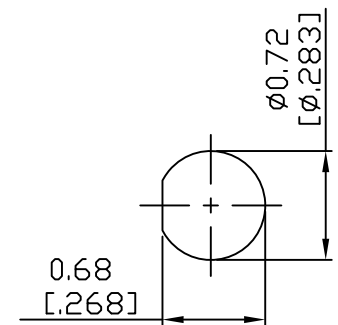

MOUNTING HOLE

					STANDARD	REV A	UNIT CM(INCH)	<b>JYE BAO CO., LTD.</b>	
					APPROVED			TAIPEI TAIWAN	
					CHECKED			DESCRIPTION CABLE ASSEMBLY SMA R/P PLUG TO SMA R/P JACK FOR BULKHEAD	
					DRAWING			JYE BAO DRAWING NO.	
					Albert			A60A95-316-XXX	
4	SMA9105-0316	SMA R/P JACK	1	EA	LENGTH TOLERANCE IS ±1.5% OR ±10MM, WHICHEVER IS GREATER.				
3	G5(F)-4.0MM-BLACK	TUBE	0.04	M					
2	RG316	CABLE	L1 (SEE TABLE)	FT					
1	SMA6100-0316	SMA R/P PLUG	1	EA					
NO.	PARTS NO.	DESCRIPTION	Q'TY	U/M					