

NO.	COMPONENTS	IMPEDANCE
1	SMA MALE RIGHT ANGLE	50 OHM
2	5002A	50 OHM
3	SLEEVE	
4	3.5 MALE	50 OHM

REVISION			
REV.	DESCRIPTON	DATE	APPROVED
-	INITIAL RELEASE	2021/02/25	

SMA MALE
RIGHT ANGLE

3.5 MALE

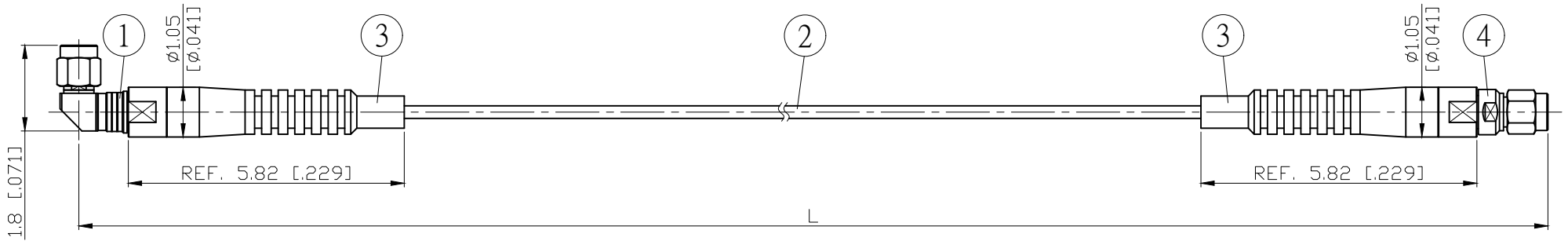

L CM (INCH)	L1 M (MM)
50 (19.685)	0.483 (482.5)
100 (39.370)	0.983 (982.5)
150 (59.055)	1.483 (1482.5)
200 (78.740)	1.983 (1982.5)
Custom length in CM	- - -

Spec	Phase stability vs bending ⁽¹⁾	Amplitude stability vs bending ⁽²⁾	Max VSWR	Max IL	Flexure life cycle ⁽³⁾
3GHz	±0.3° typ / ±0.5° max	±0.005dB typ / ±0.01dB max	1.12 : 1	≤ (0.0128dB/cm*Lcm)+0.15dB	≥ 100000
6GHz	±0.5° typ / ±0.75° max	±0.0075dB typ / ±0.015dB max	1.15 : 1	≤ (0.0189dB/cm*Lcm)+0.20dB	
12.4GHz	±0.75° typ / ±1.0° max	±0.01dB typ / ±0.02dB max	1.20 : 1	≤ (0.0293dB/cm*Lcm)+0.25dB	
18GHz	±1.0° typ / ±1.5° max	±0.015dB typ / ±0.03dB max	1.25 : 1	≤ (0.0361dB/cm*Lcm)+0.30dB	
26.5GHz	±1.5° typ / ±2.0° max	±0.02dB typ / ±0.04dB max	1.25 : 1	≤ (0.0450dB/cm*Lcm)+0.40dB	

Notes:

- Operating Temp.: -40°C / +105°C
- Static bend radius 5.1mm
- Dynamic bend radius 20mm
- RoHS Compliant

- Per IEC 60966-1, section 8.6, method 1
- Per IEC 60966-1, section 8.4
- Per IEC 60966-1, section 9.3

				STANDARD		REV	-	UNIT	CM(INCH)	JYE BAO CO., LTD.	
				APPROVED				DATE		TAIPEI TAIWAN	
				CHECKED				DATE		DESCRIPTION	
				DRAWING				DATE		CABLE ASSEMBLY SMA PLUG R/A TO 3.5 PLUG	
				Albert				DATE		JYE BAO DRAWING NO.	
								DATE		A39PC30-52A-26.5GXXX	
1	U-3.5-M	3.5 PLUG	1	EA	LENGTH TOLERANCE IS ±1.5% OR ±10MM, WHICHEVER IS GREATER.						
3	U-5002A	SLEEVE	2	EA							
2	5002A	CABLE	SEE TABLE L1	M							
1	U-SMA-M-RA	SMA PLUG R/A	1	EA							
NO.	PARTS NO.	DESCRIPTION	Q'TY	U/M							