

NO.	COMPONENTS	IMPEDANCE
1	SMA MALE RIGHT ANGLE	50 OHM
2	.047" HANDBENDABLE CABLE (= JYBAO P/N .047SRF-W-P-50)	50 OHM
3	SMP FEMALE	50 OHM

REVISION			
REV.	DESCRIPTION	DATE	APPROVED
-	INITIAL RELEASE	2022/03/22	

SMA MALE
RIGHT ANGLE

SMP FEMALE

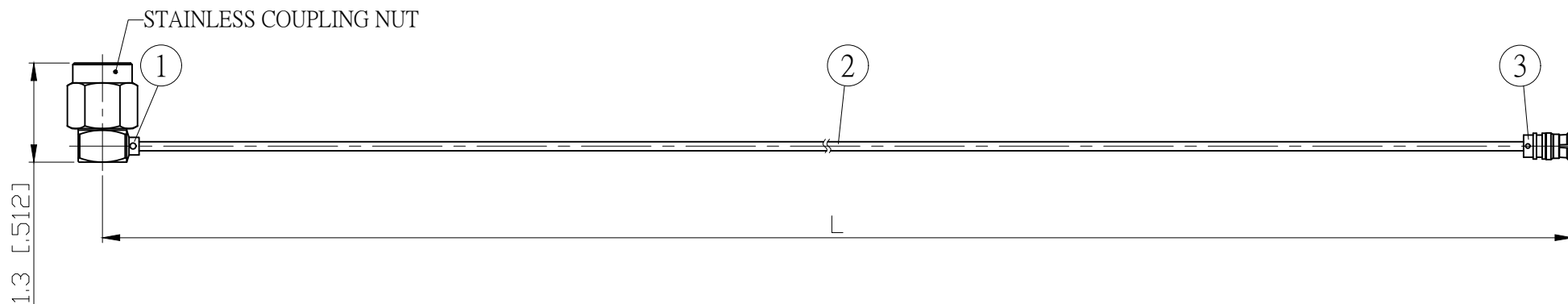

JYE BAO P/N	Freq. (GHz)	Max. Return Loss	L CM (INCH)	L1 M (MM)
A39P80-47S-18GXXX	18	-16.5dB	50 (19.685)	0.498 (497.5)
			100 (39.370)	0.998 (997.5)
			150 (59.055)	1.498 (1497.5)
			200 (78.740)	1.998 (1997.5)
			CUSTOM LENGTH IN CM	- - -

				LENGTH TOLERANCE IS $\pm 1.5\%$ OR $\pm 10\text{MM}$, WHICHEVER IS GREATER.	STANDARD	REV -	UNIT CM(INCH)	JYE BAO CO., LTD. TAIPEI TAIWAN
					APPROVED	DATE		
					CHECKED	DATE		DESCRIPTION CABLE ASSEMBLY SMA PLUG R/A TO SMP JACK
					DRAWING <i>Albert</i>	DATE		JYE BAO DRAWING NO. A39P80-47S-18GXXX
3	SMP8300-0047	SMP JACK	1	EA				
2	.047SRF-W-P-50	CABLE	SEE TABLE L1	M				
1	SMA33NPC-9047	SMA PLUG R/A	1	EA				
NO.	PARTS NO.	DESCRIPTION	QTY	U/M				