

NO.	COMPONENTS	IMPEDANCE
1	SMA MALE RIGHT ANGLE	50 OHM
2	RG58	50 OHM
3	HEAT SHRINKING TUBE	
4	N MALE RIGHT ANGLE	50 OHM

SMA MALE
RIGHT ANGLE

N MALE
RIGHT ANGLE

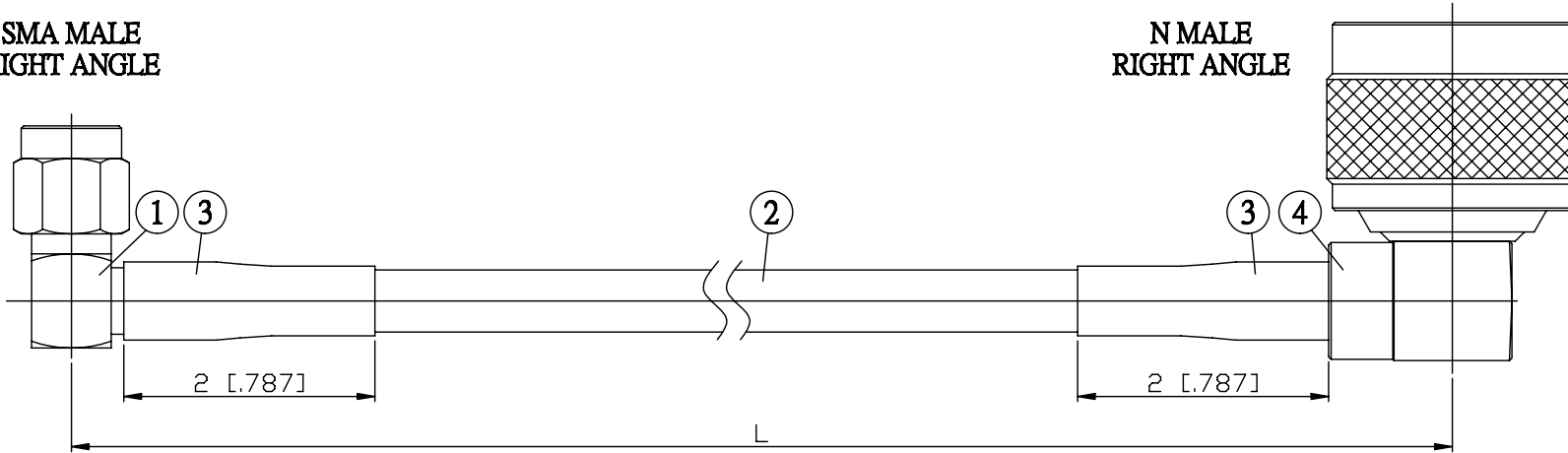

JYE BAO P/N	L CM (INCH)
A39N39-58-15	15 (5.906)
A39N39-58-30	30 (11.811)
A39N39-58-50	50 (19.685)
A39N39-58-100	100 (39.370)
A39N39-58-150	150 (59.055)
A39N39-58-200	200 (78.740)
A39N39-58-XXX	CUSTOM LENGTH IN CM

LENGTH TOLERANCE IS $\pm 1.5\%$ OR $\pm 10\text{MM}$, WHICHEVER IS GREATER.	JYE BAO CO., LTD. TAIPEI TAIWAN
	DESCRIPTION CABLE ASSEMBLY SMA PLUG R/A TO N PLUG R/A
	JYE BAO DRAWING NO. A39N39-58-XXX