

NO.	COMPONENTS	IMPEDANCE
1	SMA MALE RIGHT ANGLE	50 OHM
2	RG316	50 OHM
3	HEAT SHRINKING TUBE	
4	MCX MALE	50 OHM

SMA MALE  
RIGHT ANGLE

MCX MALE

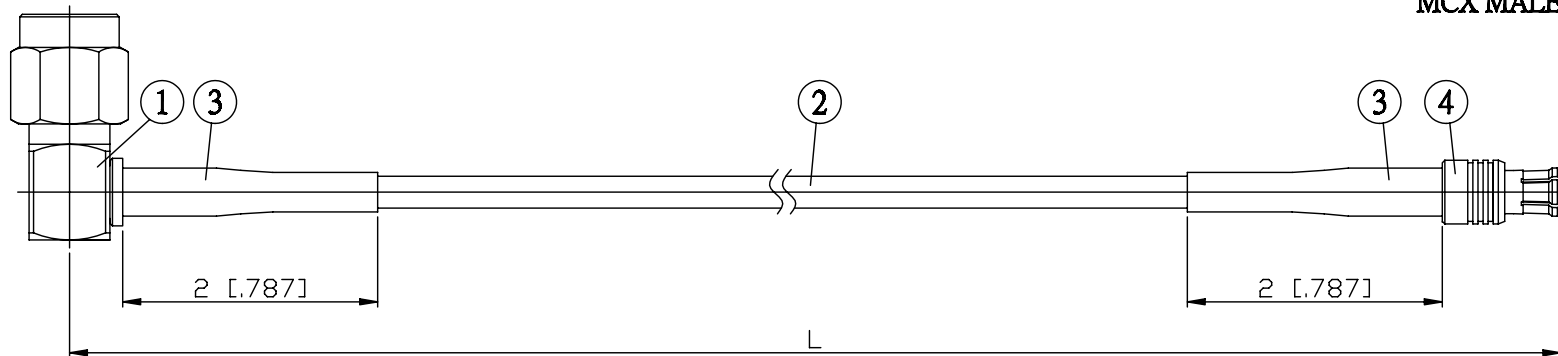

JYE BAO P/N	L CM (INCH)
A39D30-316-15	15 (5.906)
A39D30-316-30	30 (11.811)
A39D30-316-50	50 (19.685)
A39D30-316-100	100 (39.370)
A39D30-316-150	150 (59.055)
A39D30-316-200	200 (78.740)
A39D30-316-XXX	CUSTOM LENGTH IN CM

LENGTH TOLERANCE IS ±1.5% OR ±10MM, WHICHEVER IS GREATER.	<b>JYE BAO CO., LTD.</b> TAIPEI TAIWAN
	DESCRIPTION CABLE ASSEMBLY SMA PLUG R/A TO MCX PLUG
	JYE BAO DRAWING NO. A39D30-316-XXX