

NO.	COMPONENTS	IMPEDANCE
1	SMA MALE RIGHT ANGLE	50 OHM
2	RG58	50 OHM
3	HEAT SHRINKING TUBE	
4	SMA FEMALE FOR BULKHEAD	50 OHM

REVISION			
REV.	DESCRIPTON	DATE	APPROVED
-	INITIAL RELEASE	2011/03/15	
A	修正SMA螺紋規格	2013/10/01	

SMA MALE
RIGHT ANGLE

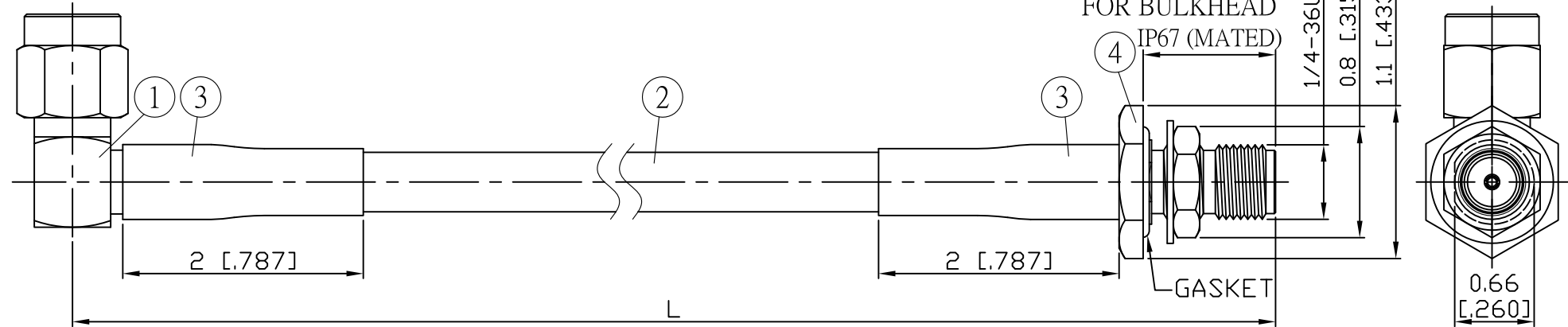

JYE BAO P/N	L CM (INCH)	L1 FT (MM)
A39A85-58-15	15 (5.906)	0.476 (145.0)
A39A85-58-30	30 (11.811)	0.968 (295.0)
A39A85-58-50	50 (19.685)	1.624 (495.0)
A39A85-58-100	100 (39.370)	3.264 (995.0)
A39A85-58-150	150 (59.055)	4.905 (1495.0)
A39A85-58-200	200 (78.740)	6.545 (1995.0)
A39A85-58-XXX	CUSTOM LENGTH IN CM	- - -

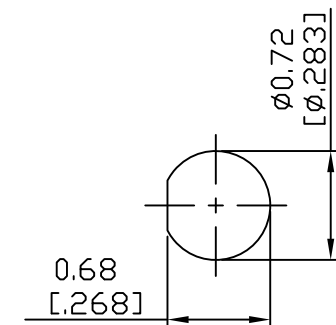

MOUNTING HOLE

4	SMA8105-0058	SMA JACK	1	EA
3	G5(F)-8.0MM-BLACK	TUBE	0.04	M
2	RG58	CABLE	L1 (SEE TABLE)	FT
1	SMA3100-9058	SMA PLUG R/A	1	EA
NO.	PARTS NO.	DESCRIPTION	Q'TY	U/M

LENGTH TOLERANCE IS ±1.5% OR ±10MM, WHICHEVER IS GREATER.	STANDARD	REV A	UNIT CM(INCH)	JYE BAO CO., LTD. TAIPEI TAIWAN
	APPROVED		DATE	
	CHECKED		DATE	
	DRAWING Albert		DATE	
DESCRIPTION CABLE ASSEMBLY SMA PLUG R/A TO SMA JACK FOR BULKHEAD				JYE BAO DRAWING NO. A39A85-58-XXX