

NO.	COMPONENTS	IMPEDANCE
1	SMA MALE	50 OHM
2	JBY240	50 OHM
3	HEAT SHRINKING TUBE	
4	TNC REVERSE POLARITY FEMALE FOR BULKHEAD	50 OHM

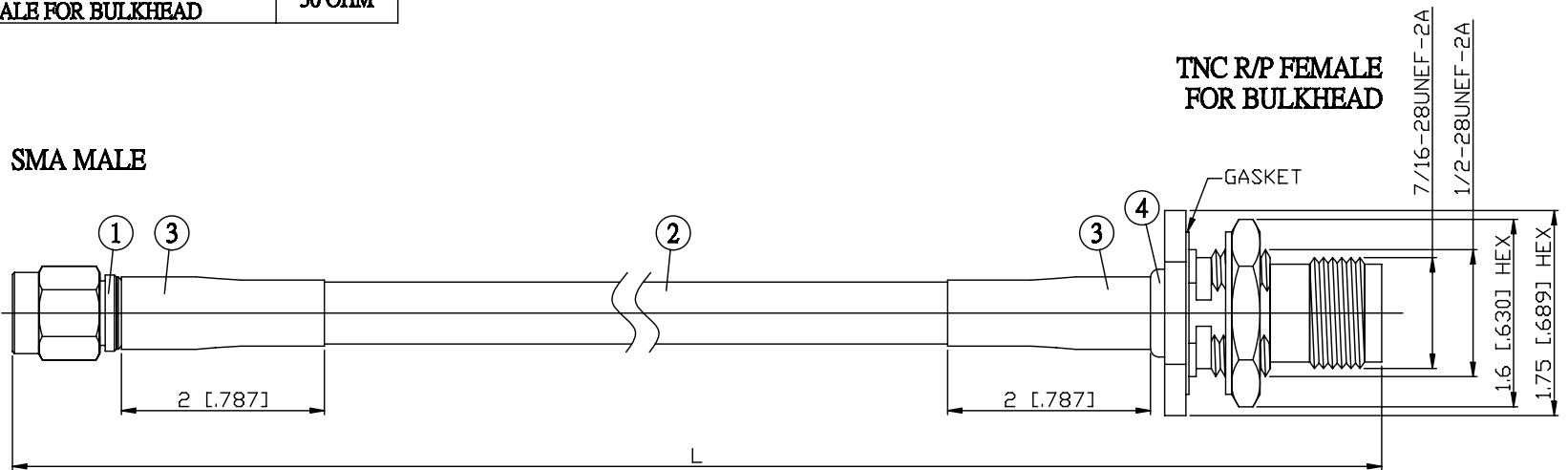

JYE BAO P/N	L CM (INCH)
A30T95-L240-15	15 (5.906)
A30T95-L240-30	30 (11.811)
A30T95-L240-50	50 (19.685)
A30T95-L240-100	100 (39.370)
A30T95-L240-150	150 (59.055)
A30T95-L240-200	200 (78.740)
A30T95-L240-XXX	CUSTOM LENGTH IN CM

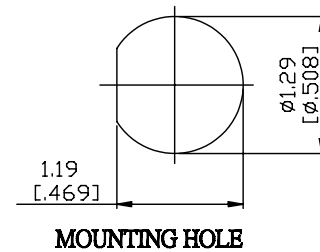

LENGTH TOLERANCE IS ±1.5% OR ±10MM, WHICHEVER IS GREATER.	JYE BAO CO., LTD. TAIPEI TAIWAN
	DESCRIPTION CABLE ASSEMBLY SMA PLUG TO TNC R/P JACK FOR BULKHEAD
	JYE BAO DRAWING NO. A30T95-L240-XXX