

NO.	COMPONENTS	IMPEDANCE
1	SMA MALE	50 OHM
2	RG316	50 OHM
3	HEAT SHRINKING TUBE	
4	SMA FEMALE FOR BULKHEAD	50 OHM

REVISION			
REV.	DESCRIPTION	DATE	APPROVED
-	INITIAL RELEASE	2011/03/15	
A	修正SMA螺紋規格	2013/10/01	

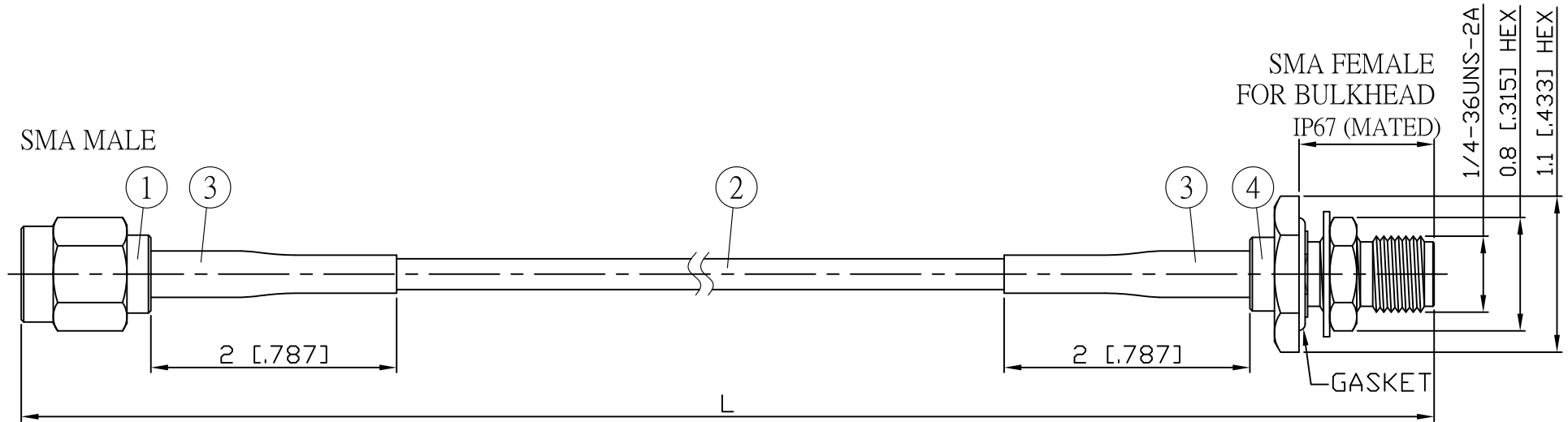

JYE BAO P/N	L CM (INCH)	L1 FT (MM)
A30A85-316-15	15 (5.906)	0.454 (138.5)
A30A85-316-30	30 (11.811)	0.947 (288.5)
A30A85-316-50	50 (19.685)	1.603 (488.5)
A30A85-316-100	100 (39.370)	3.243 (988.5)
A30A85-316-150	150 (59.055)	4.884 (1488.5)
A30A85-316-200	200 (78.740)	6.524 (1988.5)
A30A85-316-XXX	CUSTOM LENGTH IN CM	- - -

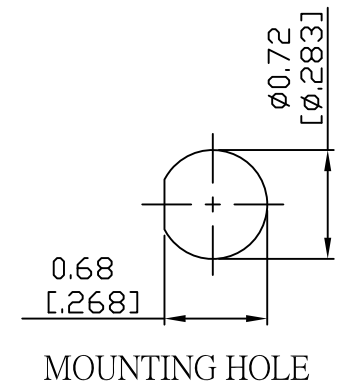

				STANDARD	REV A	UNIT CM(INCH)	JYE BAO CO., LTD.	
				APPROVED			TAIPEI TAIWAN	
				CHECKED		DATE	DESCRIPTION CABLE ASSEMBLY SMA PLUG TO SMA JACK FOR BULKHEAD	
				DRAWING	Albert	DATE	JYE BAO DRAWING NO. A30A85-316-XXX	
4	SMA8105-0316	SMA JACK	1	EA	LENGTH TOLERANCE IS ±1.5% OR ±10MM, WHICHEVER IS GREATER.			
3	G5(F)-4.0MM-BLACK	TUBE	0.04	M				
2	RG316	CABLE	L1 (SEE TABLE)	FT				
1	SMA3100-0316	SMA PLUG	1	EA				
NO.	PARTS NO.	DESCRIPTION	Q'TY	U/M				