

NO.	COMPONENTS	IMPEDANCE
1	SMA MALE	50 OHM
2	RG223	50 OHM
3	HEAT SHRINKING TUBE	
4	SMA REVERSE POLARITY MALE RIGHT ANGLE	50 OHM

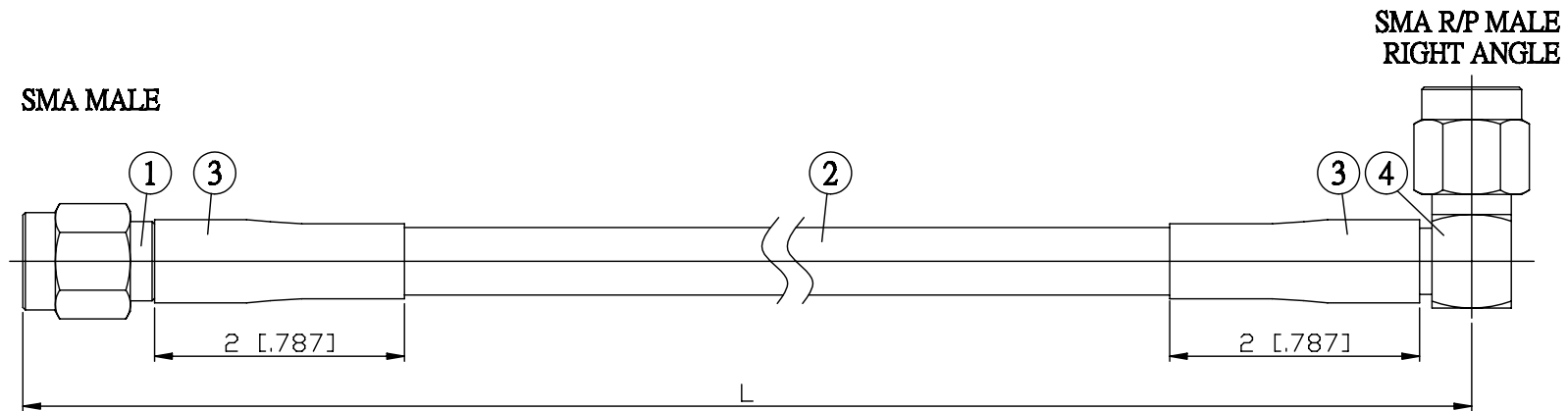

JYE BAO P/N	L CM (INCH)
A30A69-223-15	15 (5.906)
A30A69-223-30	30 (11.811)
A30A69-223-50	50 (19.685)
A30A69-223-100	100 (39.370)
A30A69-223-150	150 (59.055)
A30A69-223-200	200 (78.740)
A30A69-223-XXX	CUSTOM LENGTH IN CM

LENGTH TOLERANCE IS ±1.5% OR ±10MM, WHICHEVER IS GREATER.	JYE BAO CO., LTD. TAIPEI TAIWAN
	<small>DESCRIPTION</small> CABLE ASSEMBLY SMA PLUG TO SMA R/P PLUG R/A
	<small>JYE BAO DRAWING NO.</small> A30A69-223-XXX