

NO.	COMPONENTS	IMPEDANCE
1	SMA MALE	50 OHM
2	5003	50 OHM
3	HEAT SHRINKING TUBE	

REVISION			
REV.	DESCRIPTON	DATE	APPROVED
-	INITIAL RELEASE	2015/10/07	

SMA MALE

SMA MALE

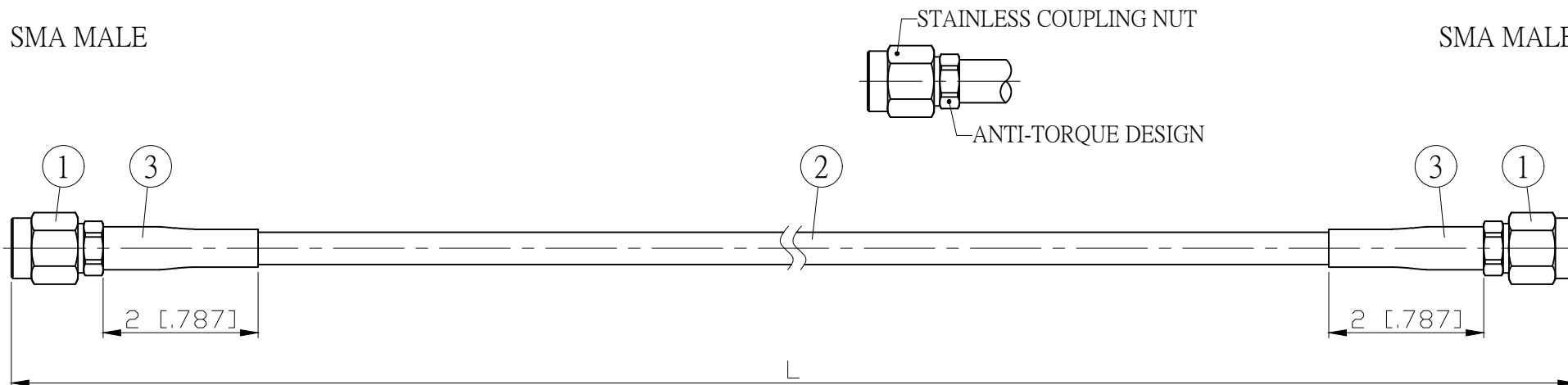

JYE BAO P/N	Freq. (GHz)	Max. Return Loss	L CM (INCH)
A30A30-53L-18GXXX	18	-18dB	50 (19.685)
			100 (39.370)
			150 (59.055)
			200 (78.740)
			CUSTOM LENGTH IN CM

LENGTH TOLERANCE IS $\pm 1.5\%$ OR $\pm 10\text{MM}$, WHICHEVER IS GREATER.

JYE BAO CO., LTD.

TAIPEI TAIWAN

DESCRIPTION
CABLE ASSEMBLY SMA PLUG TO SMA PLUG

JYE BAO DRAWING NO.
A30A30-53L-18GXXX