

O.	COMPONENTS	IMPEDANCE
1	1.85 FEMALE	50 OHM
2	6002A	50 OHM
3	SLEEVE	
4	K MALE	50 OHM

REVISION			
REV.	DESCRIPTON	DATE	APPROVED
-	INITIAL RELEASE	2021/01/05	

1.85 FEMALE

K MALE

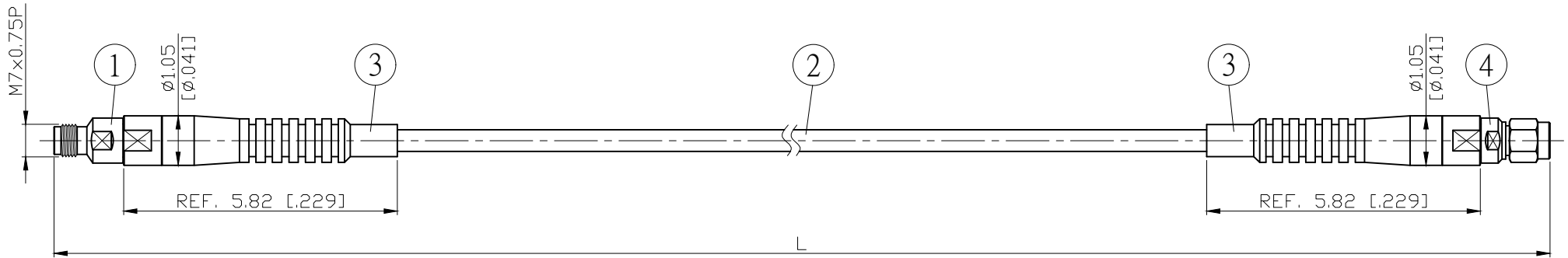

L CM (INCH)	L1 M (MM)
50 (19.685)	0.479 (478.5)
100 (39.370)	0.979 (978.5)
150 (59.055)	1.479 (1478.5)
200 (78.740)	1.979 (1978.5)
Custom length in CM	- - -

Spec	Phase stability vs bending <sup>(1)</sup>	Amplitude stability vs bending <sup>(2)</sup>	Max VSWR	Max IL	Flexure life cycle <sup>(3)</sup>
3GHz	±0.3° typ / ±0.5° max	±0.005dB typ / ±0.01dB max	1.12 : 1	≤ (0.0128dB/cm*Lcm)+0.15dB	≥ 100000
6GHz	±0.5° typ / ±0.75° max	±0.0075dB typ / ±0.015dB max	1.15 : 1	≤ (0.0189dB/cm*Lcm)+0.20dB	
12.4GHz	±0.75° typ / ±1.0° max	±0.01dB typ / ±0.02dB max	1.20 : 1	≤ (0.0293dB/cm*Lcm)+0.25dB	
18GHz	±1.0° typ / ±1.5° max	±0.015dB typ / ±0.03dB max	1.25 : 1	≤ (0.0361dB/cm*Lcm)+0.30dB	
26.5GHz	±1.5° typ / ±2.0° max	±0.02dB typ / ±0.04dB max	1.25 : 1	≤ (0.0450dB/cm*Lcm)+0.40dB	
40GHz	±2.0° typ / ±3.5° max	±0.03dB typ / ±0.06dB max	1.30 : 1	≤ (0.0568dB/cm*Lcm)+0.50dB	

Notes:

- Operating Temp.: -40°C / +85°C
- Static bend radius 13.8mm
- Dynamic bend radius 30mm
- RoHS Compliant

- (1) Per IEC 60966-1, section 8.6, method 1
- (2) Per IEC 60966-1, section 8.4
- (3) Per IEC 60966-1, section 9.3

4	U-2.92-M	K PLUG	1	EA
3	U-6002A	SLEEVE	2	EA
2	6002A	CABLE	SEE TABLE L1	M
1	U-1.85-F	1.85 JACK	1	EA
O.	PARTS NO.	DESCRIPTION	QTY	UM

LENGTH TOLERANCE IS ±1.5% OR ±10MM, WHICHEVER IS GREATER.	STANDARD	REV -	UNIT CM(INCH)	<b>JYE BAO CO., LTD.</b> TAIPEI TAIWAN
	APPROVED		DATE	
	CHECKED		DATE	
	DRAWING <i>Albert</i>		DATE	
				DESCRIPTION CABLE ASSEMBLY 1.85 JACK TO K PLUG
				JYE BAO DRAWING NO. 1880K30-62A-40GXXX