

NO.	COMPONENTS	IMPEDANCE
1	1.85 FEMALE	50 OHM
2	5002A	50 OHM
3	SLEEVE	
4	SMA FEMALE	50 OHM

REVISION			
REV.	DESCRIPTON	DATE	APPROVED
-	INITIAL RELEASE	2021/01/05	

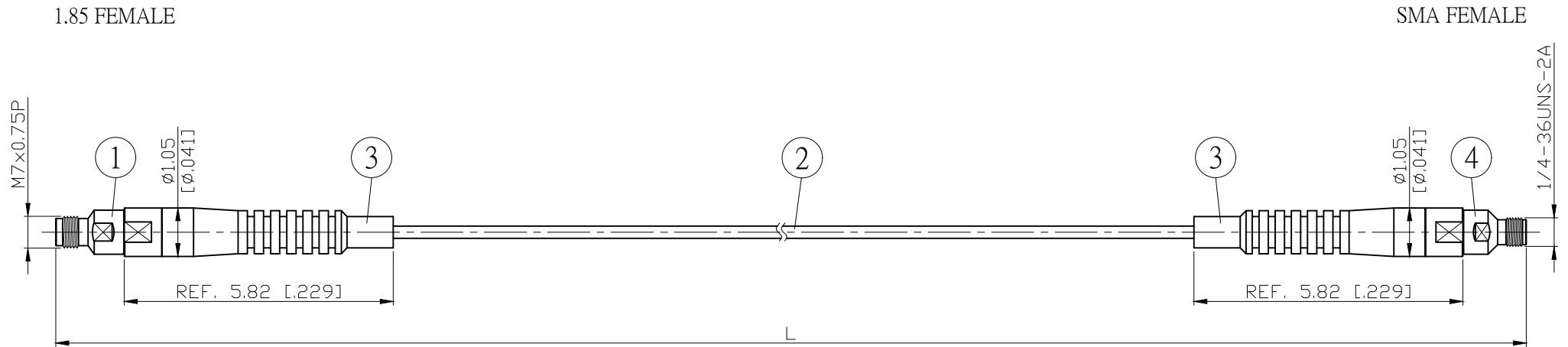

L CM (INCH)	L1 M (MM)
50 (19.685)	0.480 (479.5)
100 (39.370)	0.980 (979.5)
150 (59.055)	1.480 (1479.5)
200 (78.740)	1.980 (1979.5)
Custom length in CM	- - -

Spec	Phase stability vs bending <sup>(1)</sup>	Amplitude stability vs bending <sup>(2)</sup>	Max VSWR	Max IL	Flexure life cycle <sup>(3)</sup>
3GHz	±0.3° typ / ±0.5° max	±0.005dB typ / ±0.01dB max	1.12 : 1	≤ (0.0128dB/cm*Lcm)+0.15dB	≥ 100000
6GHz	±0.5° typ / ±0.75° max	±0.0075dB typ / ±0.015dB max	1.15 : 1	≤ (0.0189dB/cm*Lcm)+0.20dB	
12.4GHz	±0.75° typ / ±1.0° max	±0.01dB typ / ±0.02dB max	1.20 : 1	≤ (0.0293dB/cm*Lcm)+0.25dB	
18GHz	±1.0° typ / ±1.5° max	±0.015dB typ / ±0.03dB max	1.25 : 1	≤ (0.0361dB/cm*Lcm)+0.30dB	
26.5GHz	±1.5° typ / ±2.0° max	±0.02dB typ / ±0.04dB max	1.25 : 1	≤ (0.0450dB/cm*Lcm)+0.40dB	

Notes:

- Operating Temp.: -40°C / +105°C
- Static bend radius 5.1mm
- Dynamic bend radius 20mm
- RoHS Compliant

- (1) Per IEC 60966-1, section 8.6, method 1
- (2) Per IEC 60966-1, section 8.4
- (3) Per IEC 60966-1, section 9.3

NO.	PARTS NO.	DESCRIPTION	Q'TY	U/M	LENGTH TOLERANCE IS ±1.5% OR ±10MM, WHICHEVER IS GREATER.	STANDARD	REV	UNIT	<b>JYE BAO CO., LTD.</b> TAIPEI TAIWAN
4	U-SMA-F	SMA JACK	1	EA		APPROVED	-	CM(INCH)	
3	U-5002A	SLEEVE	2	EA		CHECKED		DATE	
2	5002A	CABLE	SEE TABLE L1	M		DRAWING		DATE	
1	U-1.85-F	1.85 JACK	1	EA		<i>Albert</i>		DATE	DESCRIPTION CABLE ASSEMBLY 1.85 JACK TO SMA JACK JYE BAO DRAWING NO. 1880A80-52A-26.5GXXX